

Z-6010

Compact Omnidirectional Laser Scanner

Standard Device

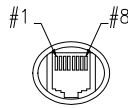
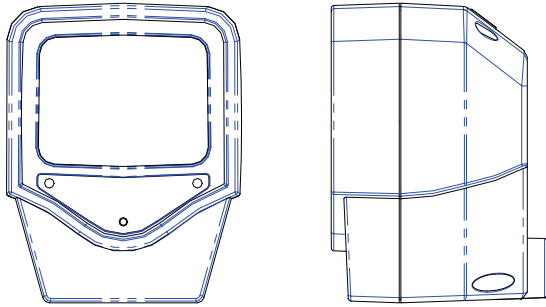

| PIN-OUT CONFIGURATION | | |
|-----------------------|----------------|---------|
| Pin | Function | |
| | Keyboard | RS-232C |
| 1 | DC + 5V input | |
| 2 | Keyboard Clock | N.C. |
| 3 | PC Clock | RTS_TTL |
| 4 | Ground | |
| 5 | N.C. | TXD_TTL |
| 6 | N.C. | RXD_TTL |
| 7 | Keyboard Data | N.C. |
| 8 | PC Data | CTS_TTL |

Standard Accessory – Fixed Stand

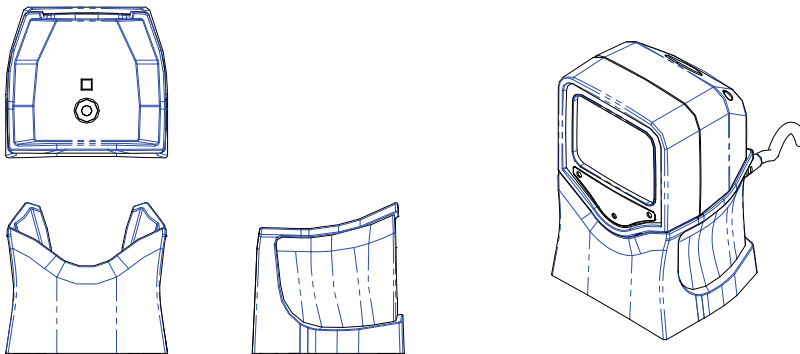

| Barcode | Model | Part No. | Remark |
|---|-------------|----------------|-----------------|
|  | Fixed Stand | 886-10HL00-001 | IBM Black Color |

Optional Accessory – Adjustable Stand

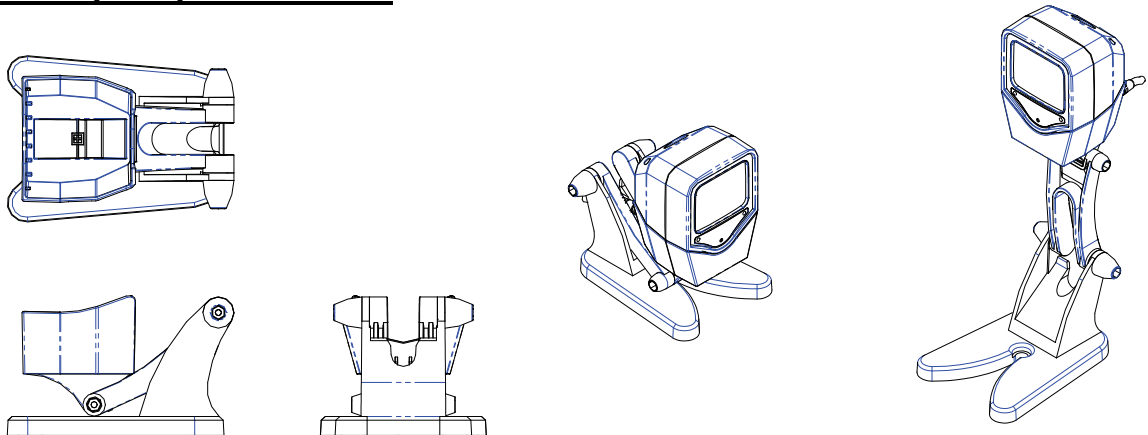









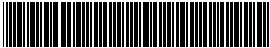





| Barcode | Model | Part No. | Remark |
|---|------------------|----------------|-----------------|
|  | Adjustable Stand | 886-10AH00-001 | IBM Black Color |

[Buyer's Guide]

Ordering Information

(Fixed stand included for standard package)



| Barcode | P/N | Model Name | Remark |
|---|----------------|--------------|--|
|  | 886-100000-000 | Z-6010 | White Housing w/Fixed Stand w/o Cable |
|  | 886-100000-001 | Z-6010 (B) | Black Housing w/Fixed Stand w/o Cable |
|  | 886-1000KP-000 | Z-6010(K) | White Housing w/PS/2 Cable w/Fixed Stand |
|  | 886-1000KP-001 | Z-6010(K)(B) | Black Housing w/PS/2 Cable w/Fixed Stand |
|  | 886-1000RP-000 | Z-6010(R) | White Housing w/RS-232 Cable (DTE Pin-out) w/Fixed Stand |
|  | 886-1000RP-001 | Z-6010(R)(B) | Black Housing w/RS-232 Cable (DTE Pin-out) w/Fixed Stand |
|  | 886-1000UB-000 | Z-6010 (U) | White Housing w/USB Cable w/Fixed Stand |
|  | 886-1000UB-001 | Z-6010(U)(B) | Black Housing w/USB Cable w/Fixed Stand |
|  | 886-100000-0NB | Z-6010 | White Housing w/o Cable w/Fixed Stand w/Neutral Gray Logo w/o Cable |
|  | 886-100000-0N1 | Z-6010 (B) | Black Housing w/o Cable w/Fixed Stand w/Neutral Gray Logo w/o Cable |
|  | 886-1000KP-0NB | Z-6010(K) | White Housing w/PS/2 Cable w/Fixed Stand w/Neutral Gray Logo |
|  | 886-1000KP-0N1 | Z-6010(K)(B) | Black Housing w/PS/2 Cable w/Fixed Stand w/Neutral Gray Logo |
|  | 886-1000RP-0NB | Z-6010(R) | White Housing w/RS-232 Cable (DTE Pin-out) w/Fixed Stand w/Neutral Gray Logo |
|  | 886-1000RP-0N1 | Z-6010(R)(B) | Black Housing w/RS-232 Cable (DTE Pin-out) w/Fixed Stand w/Neutral Gray Logo |
|  | 886-1000UB-0NB | Z-6010 (U) | White Housing w/USB Cable w/Fixed Stand w/Neutral Gray Logo |
|  | 886-1000UB-0N1 | Z-6010(U)(B) | Black Housing w/USB Cable w/Fixed Stand w/Neutral Gray Logo |

[Buyer's Guide]

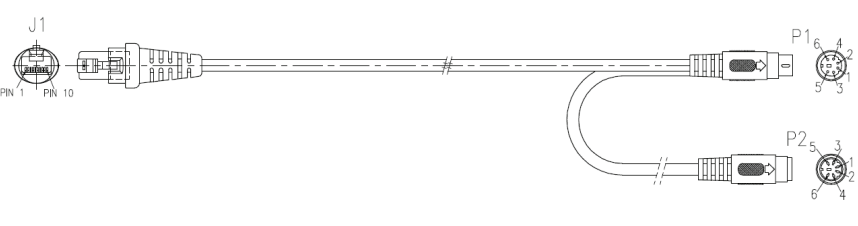

Cable Options

- The standard cable is gray, straight, and 2 meters (6.5 feet) in length.
- The standard cable options include PS/2, RS-232, or USB.
- Special Order Requirement:
ZEBEX is capable of supplying special customized cables, given that customers provide detailed pin configurations. Please contact your sales representative to further discuss the minimum order quantity of the special cables.

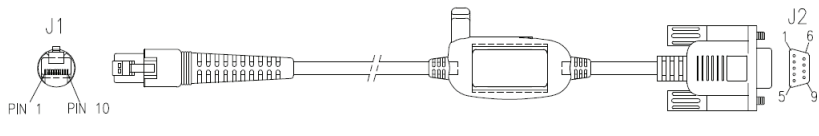

Keyboard Wedge Cable (for PS/2)

| | | | | | |
|--|--|---|-----------------|--------------------|-----------------|
|  | | MINI DIN (M) | | MINI DIN(F) | |
| | | DIN | FUNCTION | DIN | FUNCTION |
| Item Part No. 171-42K100-200 | | 1. | PC Data | 1. | KB Data |
| | | 2. | N.C. | 2. | N.C. |
| | | 3. | GND | 3. | GND |
| | | 4. | +5V | 4. | +5V |
| | | 5. | PC Clock | 5. | KB Clock |
| | | 6. | N.C. | 6. | N.C. |
| | |  | | | |

1. RS-232C Cable (DTE Pin-out)

| | | | |
|---|--|---|-----------------|
|  | | DB-9 (F) | FUNCTION |
| | | | |
| Item Part No. 171-42R442-200 | | 2 | TX |
| | | 3 | RX |
| | | 7 | CTS |
| | | 8 | RTS |
| | | 5 | GND |
| | | 9 | +5V |
| | |  | |

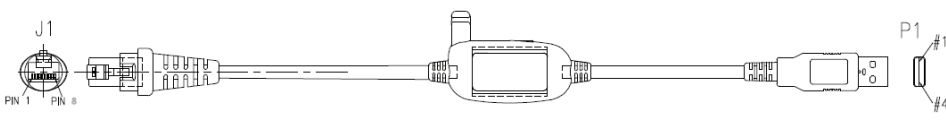
2. USB Cable

| | | | |
|--|----------------|---|-----------------|
|  | | USB TYPE A CONNECTOR | FUNCTION |
| | | | |
| HID/OPOS USB | | 1. | VCC |
| | | 2. | D- |
| | | 3. | D+ |
| | | 4. | VSS |
| Item Part No. | 171-40U322-200 |  | |

* Additional software or special firmware may be necessary for activating virtual COM or OPOS USB interface.

[Buyer's Guide]

Power Adapter

Z-6010 requires a minimum of 200mA at 5 VDC power and consumes power from the host machine. If the host can not supply sufficient power, ZEBEX provides adapters of the following plug types:

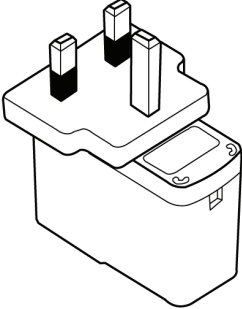
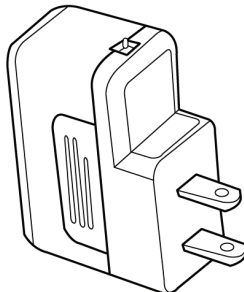
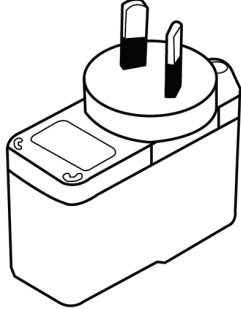
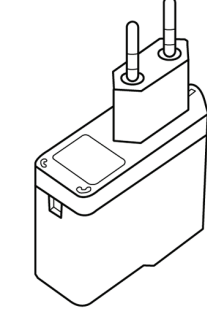
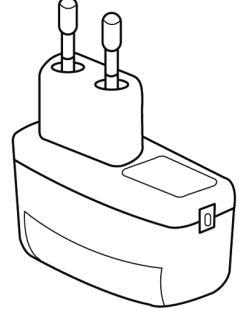
| UK Plug | US Plug | Australian Plug | European Plug | Korean Plug |
|---|---|---|--|---|
|  |  |  |  |  |

* The figures are for reference only. The adaptor form factor is subject to change without prior notice.